

SKETCH - 1 -

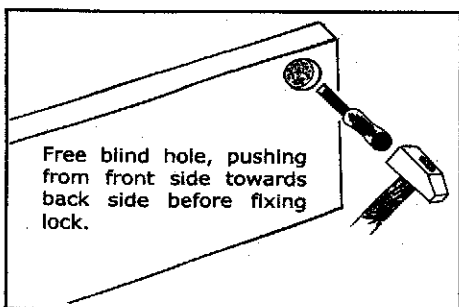
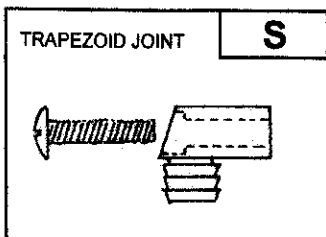
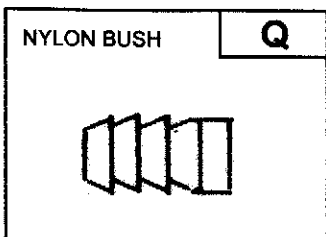
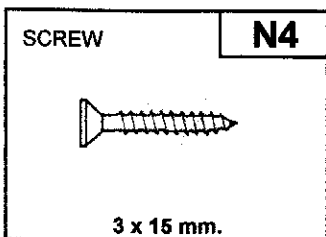
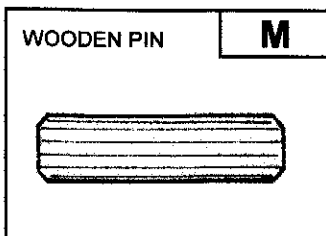
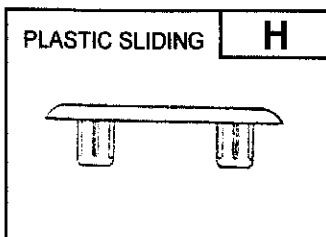
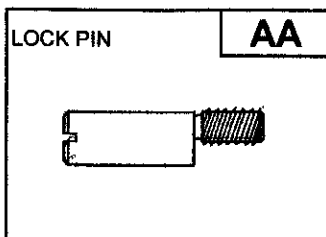
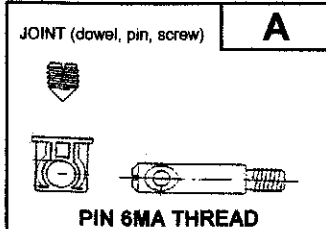

ASSEMBLING INSTRUCTIONS: "WARDROBE ART. 005"

- Insert wooden pin "M" in suitable holes dia. 8 mm. of bottom (1), internal base (2), top (3), internal side (9).
- Apply nylon bushes "Q" in suitable holes dia. 10 mm. of sides (4) (5), bottom (1), internal base (2).
- Insert plastic sliding "H" to sides (4) (5).
- Apply trapezoid joints "S" to top (3).
- Fix internal side (9) to bottom (1), internal base (2) (joint "A").
- Fix bottom (1), internal base (2), top (3) to side (4) (joint "A").
- Insert back (6) in the special millings; join side (5) to panels (1), (2), (3) (joint "A").
- Apply nylon bushes "Q" to frame (7).
- Apply frame (7) to top (3) and fix it with screw "S".
- Apply with pressure skirting board (8) to bottom (1) with pins "M" dia. 10 mm.
- Fix, from behind, wardrobe back (6) to internal base (2) and to internal side (9) with screw "N2" (**See sketch - 2 -**).
- Fix hinges bases to sides (4) (5).
- Fix hinges to wooden doors and lock to right wooden door. (**See sketch - 3 -**).
- Fix wooden doors to sides (4) (5).
- Apply lock pin "AA" to bottom (1) and top (3) using nylon bushes and adjust it in right position.
- Fix coat hanger to internal base (2) (screw "N4").
- Insert shelf holders and place shelves.

Notice:

To avoid the falling forward of the wardrobe:

- Fix angle plate on top (3) and fix it to the wall with special expansion screws

For the stability of wardrobe
fix back (6) to internal base (2) and
internal side (9), with screws ("N2")

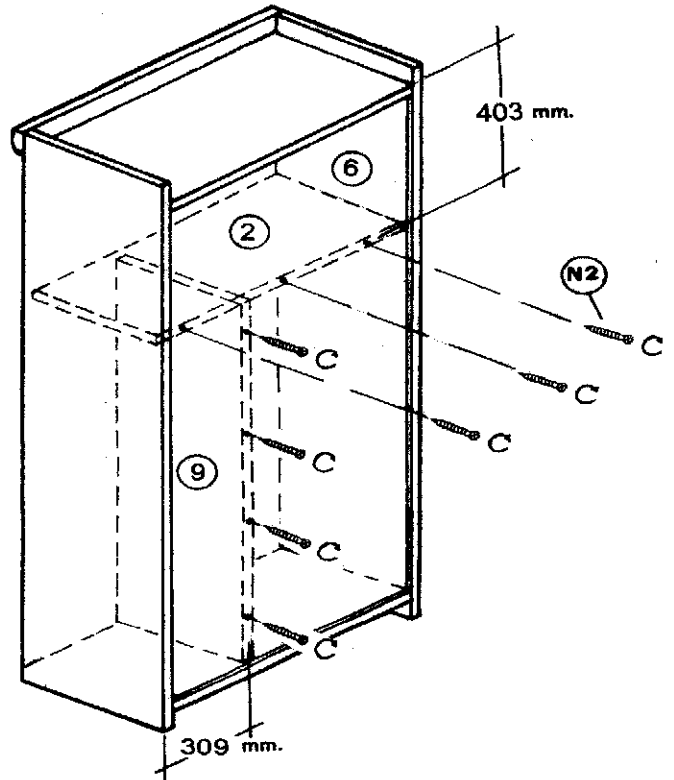
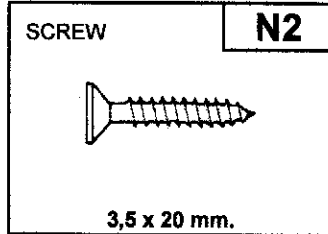

SKETCH - 2 -

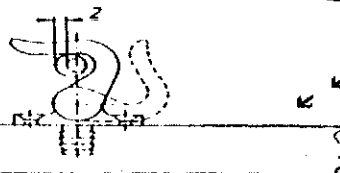
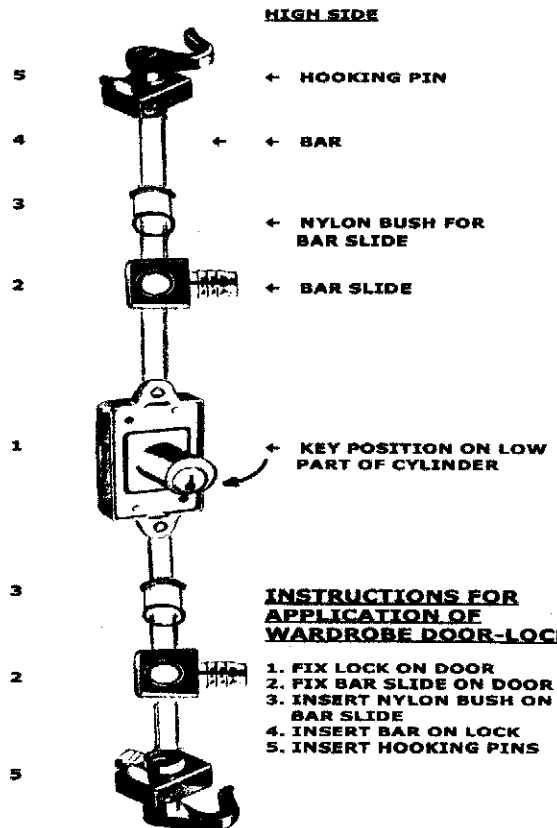
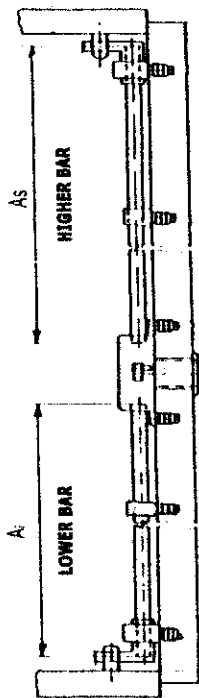

SKETCH - 3 -